

Rat and Mouse Control¹

P. G. Koehler and W. H. Kern, Jr.²

Rats and mice are important rodent pests entering Florida homes and warehouses for food and harborage (Figure 1). These rodents eat any kind of food that people eat. They also contaminate 10 times as much food as they eat, with urine, droppings and hair. They can carry at least 10 different kinds of diseases including bubonic plague, murine typhus, spirochetel jaundice, Leptospirosis, rabies, ratbite fever, and bacterial food poisoning. Many times rats bite sleeping children while trying to get bits of food on the child that were not washed off before going to bed. Rats and mice also start fires by gnawing matches and electrical wires in homes. The Norway rat, roof rat and house mouse are the most persistent rodent populations in need of control.

Norway Rats

In Florida, Norway rats are most common along the sea coasts and canals. They thrive particularly in areas where garbage is not properly stored. Although Norway rats generally prefer to eat fresh meat, fish, and grain, they can survive quite well on an ounce per day of garbage or decayed food along with an ounce of water. Frequently they range 100-150 feet from harborage in search of food or water.

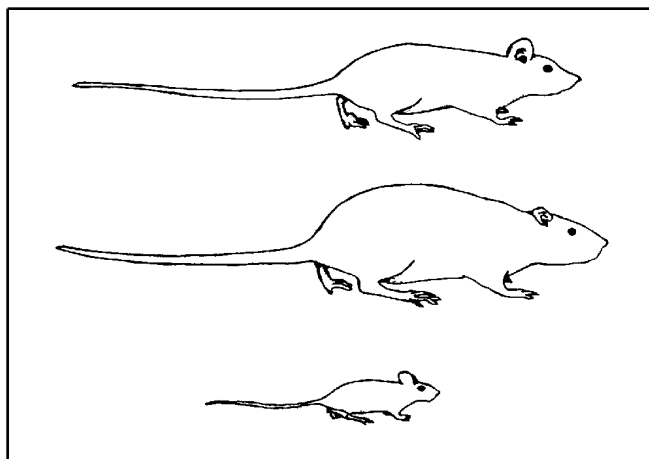

Figure 1. Roof rat (top), Norway rat (middle), and house mouse (bottom).

Norway rats are burrowers and often dig in rubbish and under buildings or concrete slabs. Burrowing can cause damage by undermining the foundations of buildings, eroding banks of levees, disfiguring landscape plantings, and blocking sewer lines.

They are reddish-brown and heavy-set with a blunt muzzle. The tail is about as long as the combined head and body. Adults weigh 3/4 to 1 pound. Their droppings are 3/4 inches long and capsule-shaped. Norway rats live about 1 year and

1. This document is ENY-224, one of a series of the Entomology and Nematology Department, Florida Cooperative Extension Service, Institute of Food and Agricultural Sciences, University of Florida. Publication date: June 1991. Revised: June 2005. Please visit the EDIS Website at <http://edis.ifas.ufl.edu>.
 2. P.G. Koehler, professor/extension entomologist and W.H. Kern, Jr., assistant professor, Entomology and Nematology Department, Cooperative Extension Service, Institute of Food and Agricultural Sciences, University of Florida, Gainesville, 32611.

reach sexual maturity in 3-5 months. They have 8-12 young per litter and up to 7 litters per year.

Roof Rats

Roof rats thrive in attics, roof spaces, palm trees, and ornamental shrubbery. They are climbers and prefer to nest off the ground. Roof rats are destructive to citrus groves, since they live in citrus trees and gnaw on the fruit. They can be quite destructive in attics, gnawing on electrical wires and rafters.

Roof rats generally prefer vegetables, fruits and grain; but they consume 1/2 to 1 ounce per day of food from various sources. Because they must have water to survive, roof rats also consume an ounce per day and will range 100-150 feet from harborages in search of water or food.

Color ranges from black to grizzled gray to tan with a light belly. The tail is longer than the combined head and body. Adults weight from 1/2 to pound. Their droppings are up to 1/2 inch long and spindle-shaped. Roof rats live about 1 year and reach sexual maturity in 3-5 months. They have 6-8 young per litter and up to 6 litters per year.

House Mice

House mice normally live outdoors in fields, occasionally migrating into structures. In houses, they live behind walls and in cabinets and furniture.

They prefer to feed on grains but usually nibble at a wide variety of foods. House mice require only 1/10 ounce of food and 1/20 ounce of water daily, surviving on food alone if it has high moisture. Frequently house mice range 10-30 feet from harborages.

House mice are brown to gray in color with the tail as long as the body. Adults weigh about 1/2 ounce. Their droppings are 1/8 inch long and rod-shaped. House mice live about 1 year and reach sexual maturity in 6 weeks. They have 5-6 young per litter and up to 8 litters per year.

Important Rat Behavior

The movement of rats and mice is usually related to food, water, or harborage. Knowing where they are likely to go is important to controlling them.

Rats use any method to get to food, water or harborage. Their excellent sense of balance enables them to run on pipes, narrow ledges, and utility wires. Rats, especially roof rats, will climb anything their claws will hold on to, including wires, pipes, and rough walls. Because rats are excellent swimmers, they often live in sewers and occasionally enter homes through toilets.

Rats like to use regular paths or runways along walls or behind debris. To get food in the open, they will run behind things to get as close to the food as possible. They are afraid of strange objects or strange food and may avoid both.

Norway and roof rats are both aggressive species. The Norways are usually more aggressive, driving roofs from the territory. Both species are seldom found in the same building.

Rats and mice frequently gnaw on their surroundings. Their teeth grow 4 1/2 to 5 1/2 inches per year and only gnawing keeps them short and sharp.

Rats and mice are active mostly at night. Rats show greatest activity the first half of the night, if food is abundant. Mice usually are active at night both right after dark and between midnight and dawn. Both rats and mice will be active during daytime hours when food is scarce, when there is an overpopulation of rats, or when a poison has been used and the population is sick.

Recognizing Rat and Mouse Signs

Since rats and mice are active at night and are rarely seen during the day, it is necessary to recognize signs of their activity.

Droppings and Urine - Most people first recognize rodent problems by finding droppings (Figure 2) or urine stains in and around buildings. Rodents usually have favorite toilet areas but will void almost anywhere. Old droppings are gray, dusty, and will crumble. Fresh droppings are black, shiny,

and puttylike. Rodents urinate while running, and the streaks are characteristic. The urine glows under ultraviolet lights and glows blue-white when fresh.



Figure 2. Droppings of roof rat (1/2", left), Norway rat (3/4", middle) and house mouse (1/8", right).

Gnawed Objects - Rodents gnaw every day in order to keep their teeth short and sharp. Rats also gnaw to gain entrance or to obtain food. Teeth marks on food, building materials, wire, and edges of beams are indications of gnawing. They will gnaw holes in wooden walls, pressed wood, and posts. Fresh gnawing in wood is usually light-colored with sharp, splintery edges. Old gnawing is smooth and darker.

Runways - Rats habitually use the same paths or runways between harborage and food or water. Outside runways are paths 2-3 inches wide and appear as smooth, hardpacked trails under vegetation. Indoors, runways are usually found along walls. Undisturbed cobwebs or dust indicates runways are not being used.

Rubmarks - Along runways, dark greasy rubmarks appear from contact with the rodent's body. Rubmarks on walls appear as black smudges left by the rodent. New rubmarks are soft and will smudge. Old rubmarks are brittle and will flake when scratched. Rafters may show swing marks of roof rats.

Tracks - To detect rodent activity, spread dust material like talcum powder along runways. Footmarks of rats (5-toe hind foot, 4-toe front foot) or tail drag marks will show in the powder.

Burrows - Norway rats burrow for nesting and harborage. Burrows are usually found in earth banks, along walls, under rubbish and concrete slabs. Freshly dug dirt scattered in front of 3-inch openings with runways leading to the openings is characteristic. Burrows usually are 18 inches deep in most soils. Slick, hardpacked runways indicate an old established colony.

Live Rats and Dead Rats - The sighting of live rats is a sure sign of infestation. Sightings in the daytime indicate large populations, disease or poisoning. Mummified rat carcasses may indicate a former infestation although many fresh carcasses suggest disease or poisoning.

Sound - Usually rodent sounds are heard at night or in quiet areas. Rodents moving at night often scratch, gnaw, and fight. The young often squeak while in the nest.

Rodent Control

To control rats, implement the following procedures:

Rodentproofing - Rodentproofing is changing the structure of buildings in order to prevent entry of rats and mice. In considering rodentproofing, you must know that

- Rats can squeeze through cracks 1/2 inch wide; mice, 1/4 inch wide. Any place a pencil can be poked, a mouse can go.
- Rats can climb the inside of vertical pipes 1 1/2 - 4 inches in diameter.
- Rats can climb the outside of vertical pipes up to 3 inches in diameter and any size if within 3 inches of a wall.
- Rats can jump vertically 36 inches, horizontally 48 inches, and reach horizontally or vertically 15 inches.
- Rats can jump 8 feet from a tree to a house if the branch is 15 feet above the roof.

Rodentproofing requires the use of rodent-resistant materials. The following materials are considered rodent resistant:

- Sheet metal (26 gauge or heavier).
- Perforated metal (24 gauge or heavier with openings no more than 1/4 inch).
- Hardware cloth (19 gauge or heavier with openings no more than 1/4 inch).

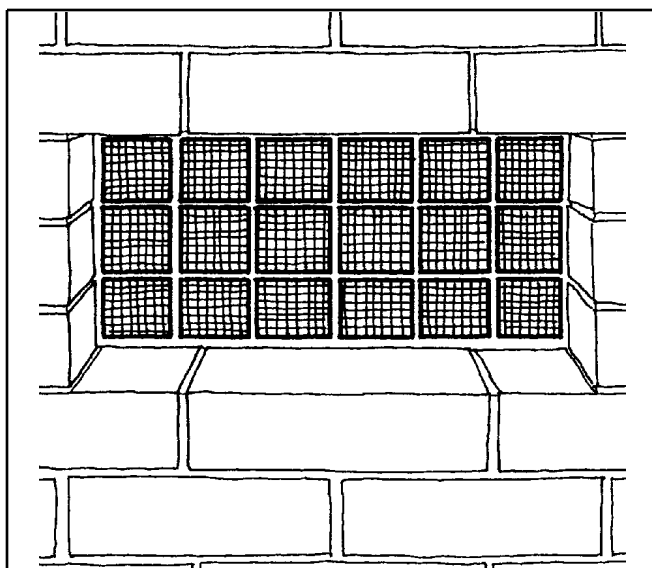

Figure 3. Rodentproofing a vent.

- Brick with mortared joints.
- Cement mortar (1:3 mixture).
- Concrete (1:2:4 mixture).

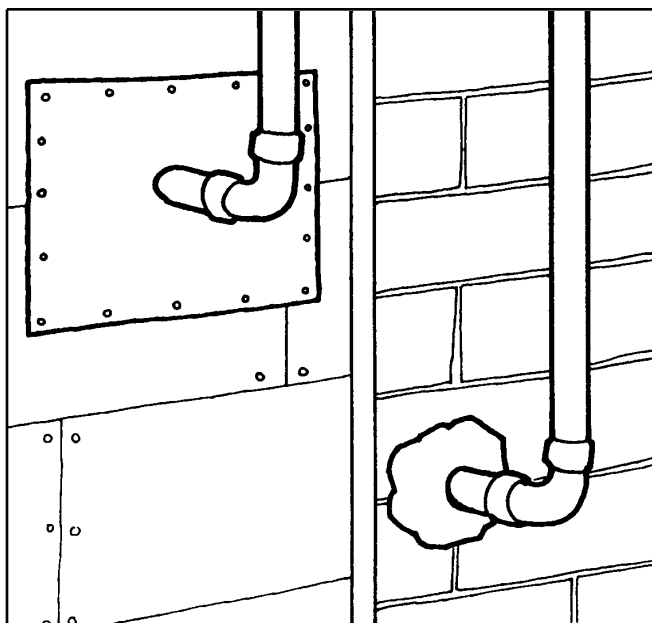

Figure 4. Rodentproofing openings around pipes with sheetmetal (left) and concrete (right).

A gnawing edge is the edge of substances which rats can gnaw through. The gnawing edges must be protected with rodent-resistant materials. Places to rodentproof are edges of doors, windows, holes where pipes enter buildings, ventilation holes in foundations, roof vents, exhaust fans, and eave vents. Rodents can also enter homes through toilets.

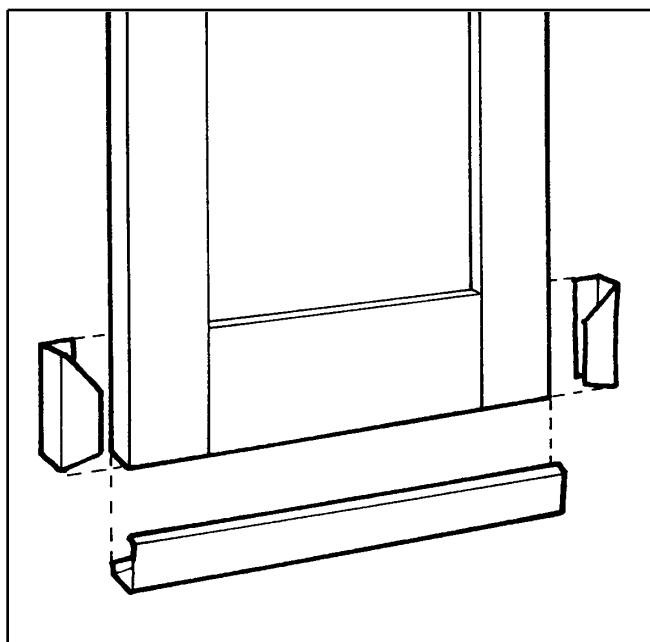

Figure 5. Rodentproofing a door, placing channel at bottom and cuffs at sides over channel.

To be effective, rodentproofing must block all possible rodent entry points. During the first 2 weeks of completing rodentproofing, searching rodents will find breaks in the rodentproofing. Inspect frequently during this time and promptly repair any breaks. It will also be necessary to eliminate the rodents trapped indoors due to rodentproofing.

Sanitation - Good housekeeping or sanitation is a basic factor in rodent control. Eliminating food, water, and harborage for rats and mice can reduce rodent populations rapidly. To implement sanitation practices:

- Clean up garbage and rubbish.
- Properly store garbage (Metal garbage cans should have tight fitting lids).
- Properly store food (store raw or prepared foods and refuse indoors in covered, ratproof containers or in ratproof rooms).
- Store pet food and bird seed in rat proof containers.
- Remove harborages (remove piles of rubbish, trash, junk, boxes, and protected enclosures).
- Dry up sources of water.

- Pick fruits and vegetables when ripe so rodents will not feed on them.

Sanitation must be used constantly in rodent control to be effective. Yearly clean-up programs are generally ineffective for rodent control.

Predators - Many people have relied on cats and dogs to control rats, but in general cats and dogs are not good tools for control. Food put out for pets is excellent rat food. Most people put out more food than the pet can consume in one day. Rats then clean the bowl overnight. Because pets are well-fed, they are too lazy to hunt. Studies have shown that although predators can keep an area rat free, they can not remove an existing infestation.

Birds of prey, hawks and owls, feed on large numbers of rodents. Barn owls are exceptional rat killers and a pair can be expected to kill several hundred rats over a one year period.

Many species of non-poisonous snakes are very beneficial in rodent control. Snakes such as rat snakes, king snakes, pine snakes, black racers, and coach whips eat numerous rodents and are important in controlling rodent populations. Do not kill non-poisonous snakes.

Trapping - Trapping is an underrated method of controlling rodents. One reason trapping is often overlooked is that snap traps have been around for a long time and are cheap. Traps can be used to eliminate rats where poison baits would be dangerous, to avoid dead rat odors, and to eliminate bait-shy rats.

It is important to place traps where the rats are. Rats and mice are used to human odors so there is no need to use gloves when handling traps. Since mice travel only 10-30 feet but rats travel 100-150 feet from harborages, more traps are needed to trap mice than rats in a house.

Rats and mice also have different behavior around new objects. Rats are cautious, and it may be a week before they approach a trap. Mice are curious and will normally approach traps the first night. If you don't catch a mouse in the first few nights, the trap is in the wrong location. To help rats overcome

trap shyness, place traps unset, in place, for several days. This allows rats to overcome shyness and results in better catches.

Baited traps rely on the rat's being attracted for feeding. The bait must compete with other available foods, so no one bait is ever the best bait for all locations. Rodents living on garbage or spoiled food prefer something fresh. The following are some baits that have proven to be successful:

- Whole nuts for rats and mice.
- Raisins or grapes for roof rats.
- Sardines packed in oil for Norway rats.
- Peanuts or peanut butter for rats and mice (soak whole peanuts in water overnight; old peanut butter becomes rancid so replace it frequently).
- Dry rolled oatmeal is excellent for mice.
- Bacon squares.
- Small wads of cotton for mice and rats (they look for nest material).
- Gumdrops for mice.

Baited traps should be set a right angles to rat runs (Figure 6). Traps can be nailed to rafters and beams to take advantage of areas where rats travel. Set traps along walls, behind furniture, and near holes. Remember to set traps where children and pets will not be hurt.

Runway traps - catch rats when they accidentally bump the trigger. Runway traps are available or can be made from snap traps by enlarging the trigger with cardboard, hardware cloth, or screening (Figure 7). There is no bait to go stale, so there is an increased chance of success. In placing runway traps, the trap should be placed at right angles to the wall or along runways. To hold the trap in place on pipes or rafters, use rubber bands, nails, or hose clamps.

Glue boards - Special glue can be placed in pie tins or paper plates. The glues do not harden but will hold a rat in place. Other rats become curious and also get caught. Placing a small piece of bait in the center of a glue board can increase effectiveness.

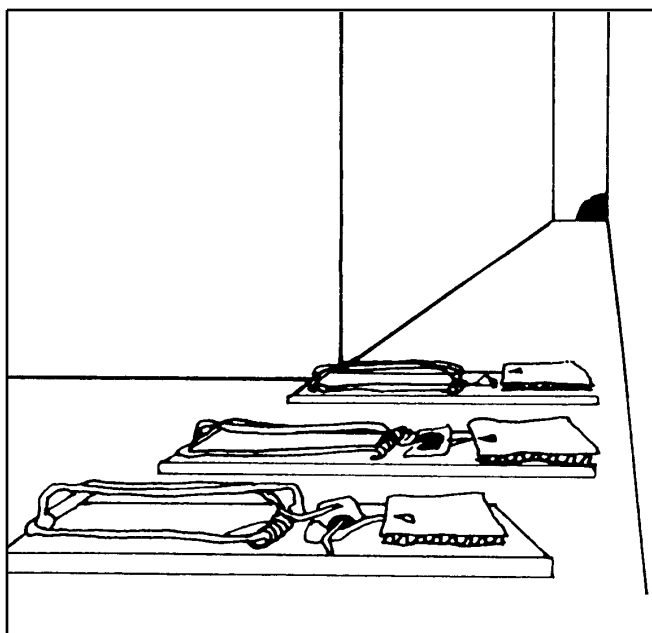

Figure 6. Traps at right angles to rat run.

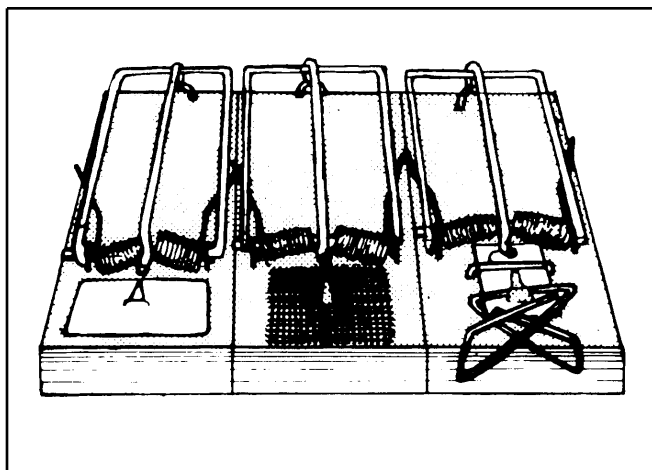

Figure 7. Runway traps made from enlarged snaptraps.

Dusty and wet conditions will impair the trap's effectiveness. Glue boards are better suited for mice and safe for children and pets. Boards may be cleaned with cooking oil.

Poison Baits - Traps are effective usually when dealing with small numbers of rats or mice. When rats are plentiful or where unsanitary conditions exist with harborage, poisoned baits are an effective tool to use with trapping.

Poison baits are available as ready to use, premixed baits. They come in many forms; parafinized blocks for outdoor use and high humidity areas, treated meal, seeds, or parafinized pellets in bulk or in "place packs" for indoor use. Water baits

are sold as packets of concentrate that are mixed with water. They are administered with a chick fount, available at most feed stores, and are useful in areas where rodent food is abundant but water is in short supply.

There are three types of rodenticides; acute toxins, calcium releasers and anticoagulants. Most acute toxins are no longer available due to the risk of accidental poisoning. Zinc phosphide baits react with stomach acids to produce phosphine gas. This product is restricted use and mostly used for agricultural rodent control, because it offers little risk of secondary poisoning of beneficial predators. It has no antidote and is not appropriate for use around children, pets, or livestock. One new acute toxin that is considered safe and effective is bromethalin. Bromethalin is a mitochondrial poison that shuts down the rodent body's ability to produce energy. It also has no antidote, and is considered a minor threat of secondary poisoning because it causes the rodent to stop feeding days before it dies, so most of the poison has been excreted prior to death and possible ingestion by a predator or pet. Vitamin D₃ or cholecalciferol is a calcium releaser that causes too much calcium to be released into the blood, resulting in kidney, liver, or heart failure. The advantages of vitamin D₃ are that it kills anticoagulant-resistant rodents and there is no problem of secondary poisoning of pests or wildlife that eat poisoned rodents. The most common rodenticides are the anticoagulants. The older, multidose anticoagulants include chlorophacinone, coumafuryl, diphacinone, pivalyn, valone, and warfarin. The newer generation of anticoagulants are effective after a single dose and include brodifacoum, bromadiolone, and difethalone. The single-dose anticoagulants are generally effective against rodents resistant to the older multidose compounds. Rodents poisoned with anticoagulants die from bleeding internally. Because the effects show up days after taking the bait, they do not associate their poisoning with the bait. Anti-coagulants are considered safer rodenticides than the acute poisons, because larger doses are necessary to poison humans or pets and these poisons have a simple antidote, Vitamin K₁.

Whenever a rodenticide is used, safety must be the first consideration. Poison baits must be placed where they are inaccessible to children, pets, livestock, and wildlife. Where rodent runs are exposed and in all outdoor situations, tamper proof bait boxes must be used. A tamper-proof bait box or station must be inaccessible to a 4 year old child or a dog. This means that the station can not be opened and the bait can not shaken out. Bait blocks must be secured inside the station or if loose bait pellets or meal is used, then the station must be secured to the ground so a child, dog or raccoon could not move it. Baits stations should always be placed near where rats live and breed or along travel routes.

About 1 pound of anticoagulant bait should control most rats in and around homes. The baits should be placed in stations with 1/4 pound of bait per station (Figure 8). Shallow containers for holding the bait are best. For added effect, water may be provided separately for the rats to drink. Pick up dead rats wherever they are noticed. A few cases of pet poisoning have been reported when pets feed on dead rats or mice. When rats die in areas where they can not be removed, it may be necessary to ventilate the area or use odor absorbent or masking products. Usually anticoagulant poisoned mice are dehydrated and do not produce severe odor after death. Rats on the other hand are large enough to produce an unpleasant odor for up to two-four weeks if they die in inaccessible locations.

When you control your rats, encourage your neighbor to control their rats at the same time. The greater the area that is controlled, the more effective the results will be and the longer it will take new rats to migrate back to your property.

Check with your local county health department to determine whether a rodent control project is active in your neighborhood. They may be able to offer advice and aid in controlling rats. Remember it is no disgrace to acquire some rats, but it is a dangerous to maintain them.

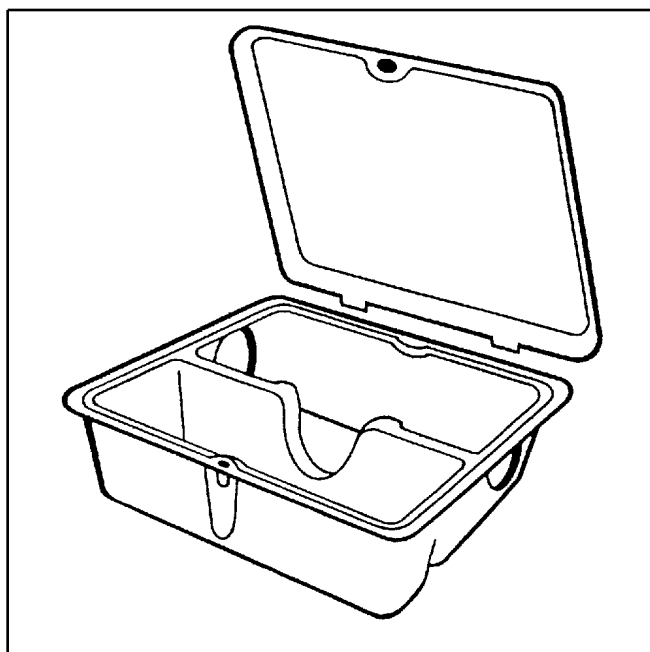

Figure 8. Tamperproof rodent bait station.