

FUN WITH CLOTHES

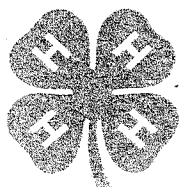

Florida 4-H Clothing and Textiles Program

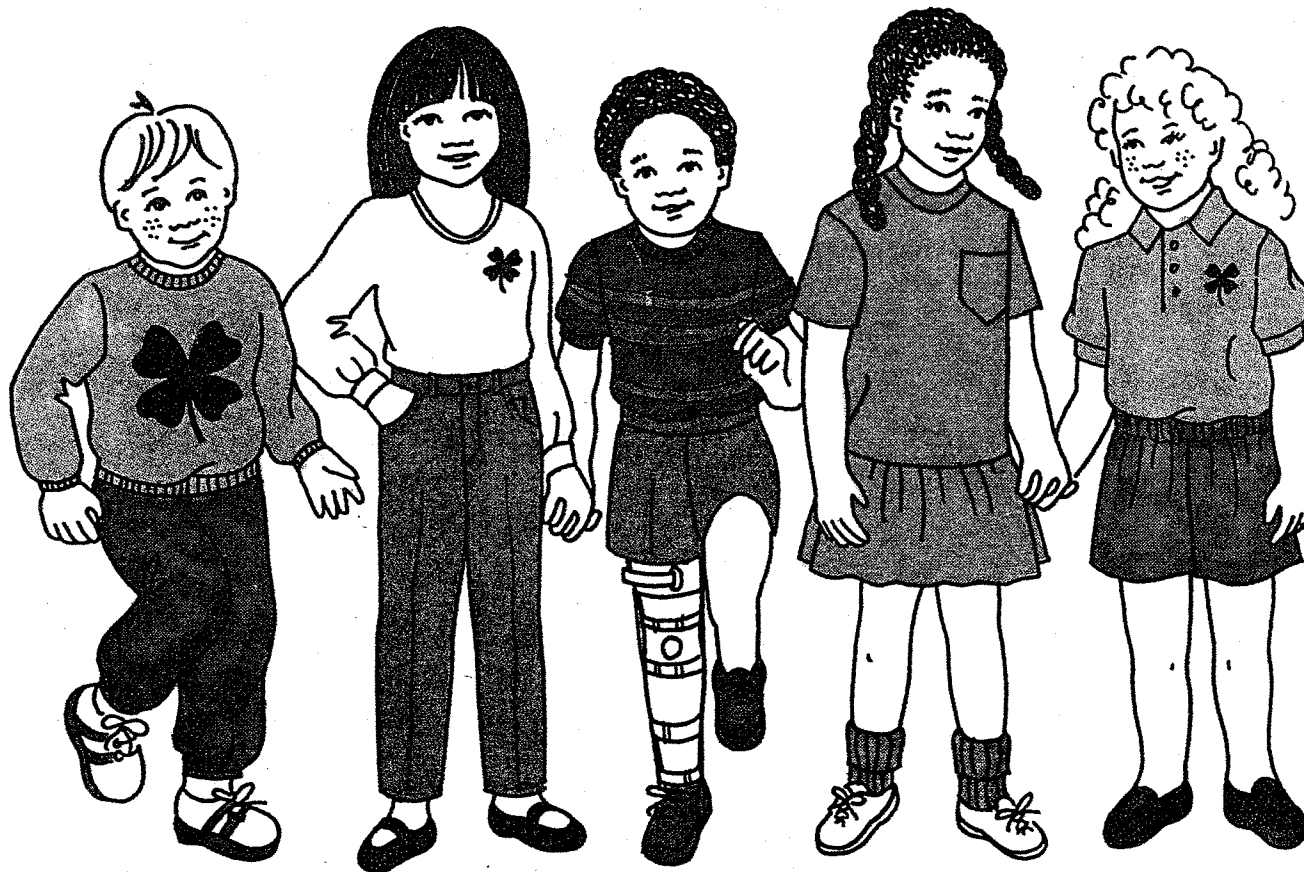
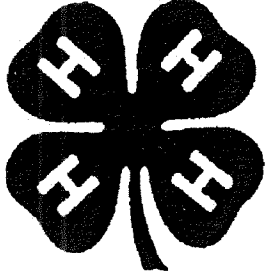

Special Thanks...

This 4-H Clothing and Textiles Project was partially supported by gifts and grants from Elna, Inc., Singer Sewing Machine Company, Soap and Detergent Association, and the American Home Sewing and Crafts Association.

Acknowledgements...

Fun With Clothes includes an adaptation of "Stitchin' Time" and "A Closer Look at Fabrics" activities from Minnesota 4-H Cloverbuds Discovery Program and the Pennsylvania 4-H Clothing Project Series, respectively.

Appreciation and thanks are extended to the contributions of ideas, concepts and activities made by the Design Team Members and pilot sites.

Special acknowledgement of contributions and thanks are also extended to Nancy O'Neil, Artist, for graphic illustrations and to Nancy Stuart and Angela Frampton, Department of 4-H and Other Youth Programs, for the word processing and computer graphics.

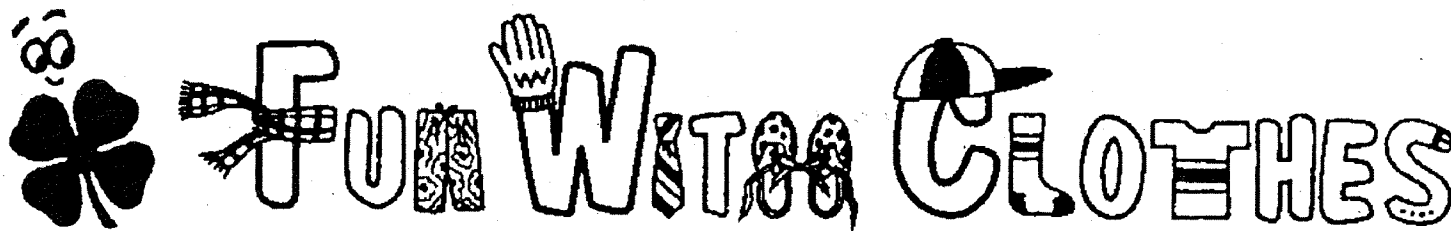

FUN WITH CLOTHES

In this project you will have lots of fun learning about lots of things! It lets you be creative, make choices and is challenging.

What is it all about? Here are a few topics:

Sewing skills...

- making lots of creative projects!
- exploring fiber and fabrics!

Looking good...

- improving your posture.
- choosing the right clothes!
- caring for your clothes.

Shopping skills...

- knowing where to shop.
- looking at labels!

Special topics...

- clothes from around the world!
- clothes for special jobs.

Come on, let's get started...



*Have
Fun!*



My Sewing Tool Box



You will need:

- small cardboard box
- scissors
- glue
- fabric scraps, colored paper

What you do:

- Decorate your sewing box.
- Place your sewing tools inside.

Sewing Tools:

- ✓ pins
- ✓ needles
- ✓ scissors
- ✓ ruler
- ✓ thread



Find your sewing tools!

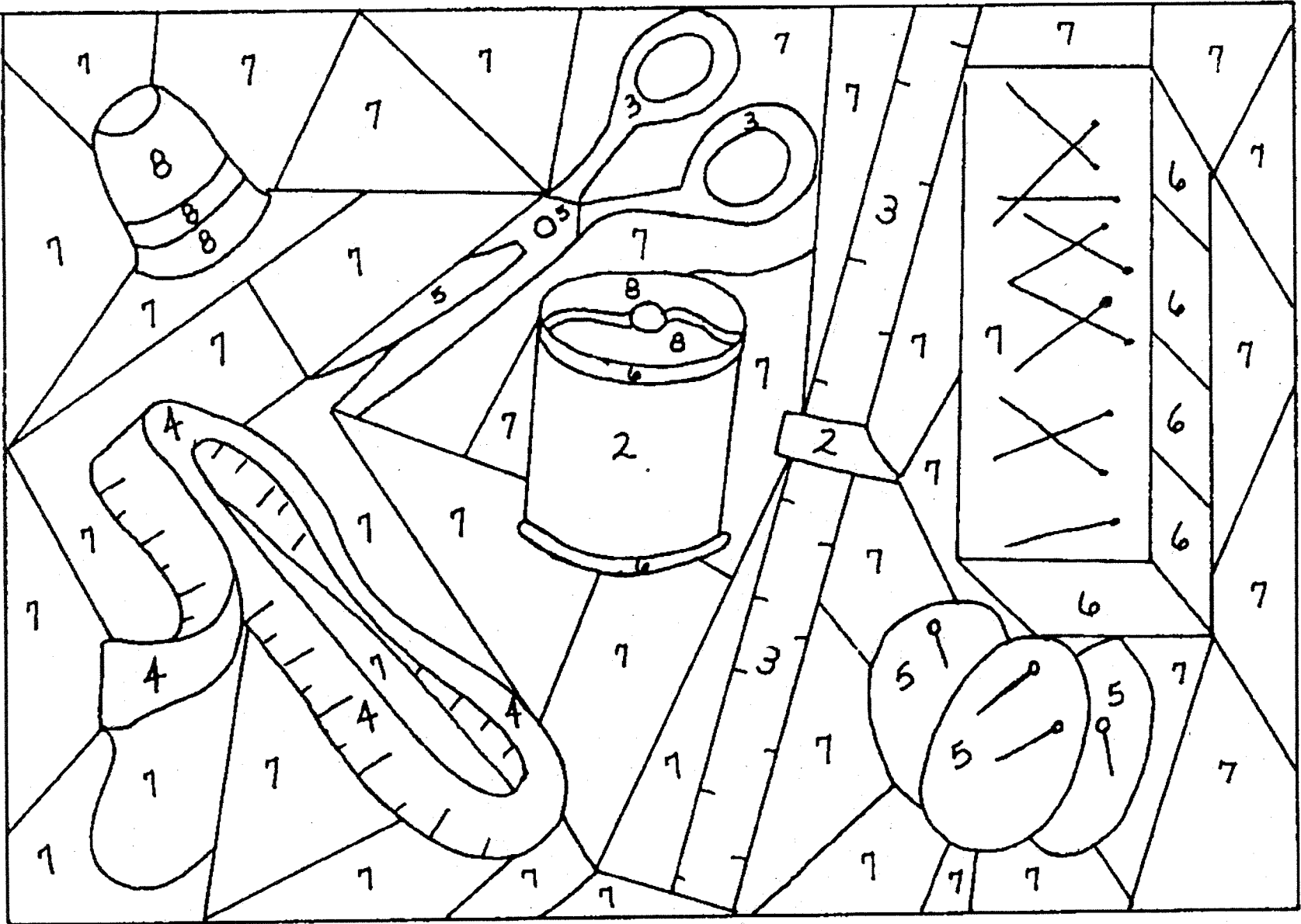

Color Codes: 1 = green 2 = red 3 = blue 4 = yellow 5 = brown 6 = black 7 = white 8 = orange

Stitchin' Time

You need:

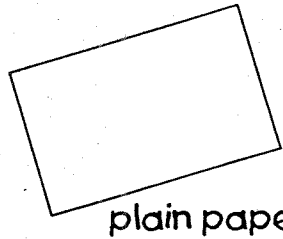

plain paper



needle



pencil

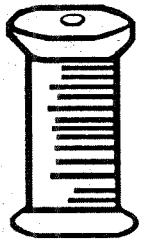

thread



tracing paper

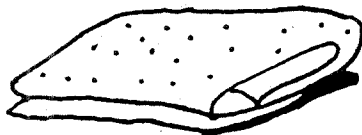

cloth

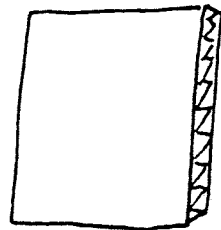

cardboard
(1" smaller than
picture)



masking tape

You do:

①

Draw a picture of a house, tree, pet or other favorite thing.

②

Put tracing paper under your drawing and lightly trace the lines onto the cloth.

③

Thread your needle. Double the thread and make a knot at the end.

④

Push the needle through the backside of the cloth. Pull the thread through until the knot stops it. Stitch in and out of the cloth along the lines.

⑤

Stretch your cloth picture over cardboard. Tape edges around the back. Punch holes and tie yarn to hang.

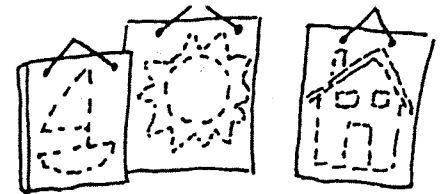
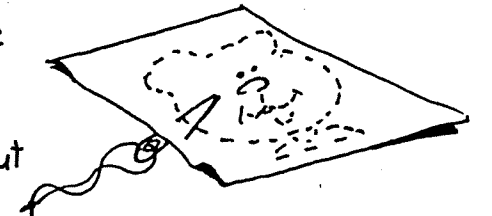
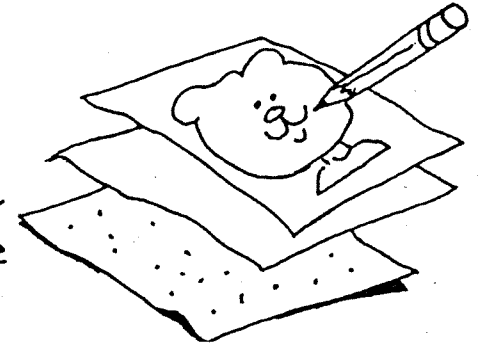

Here are some examples!

A "BOOK" of Needles

You will need:

- small scraps of felt fabric
- needle and thread
- scissors

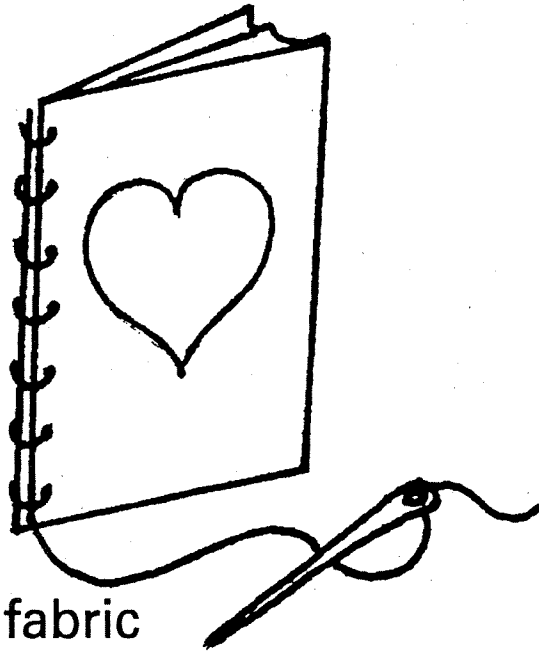

What you do:

- ✓ Cut 4 pieces of the same shape.
- ✓ Place pieces on top of each other.
- ✓ On one side, use overhand stitch to connect all pieces.
- ✓ Insert your needles to complete your book!

Pin

Pillows

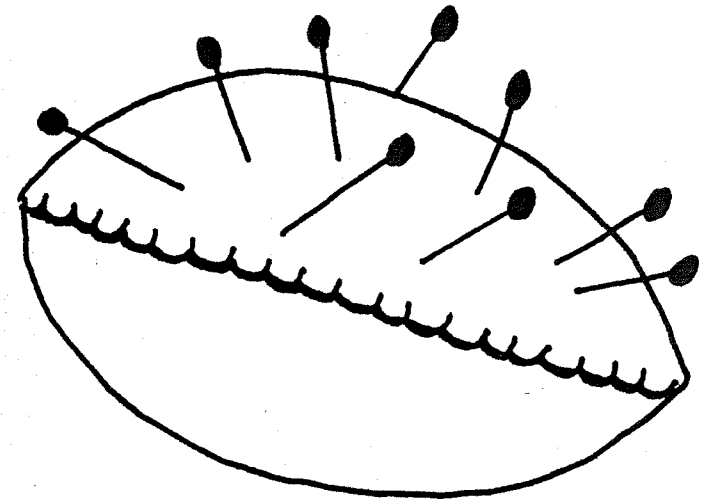

Practice your stitching by making this pin cushion.

You will need:

- felt fabric
- needle
- thread
- scissors
- stuffing (cotton, fiberfill, or old panty hose)

What you do:

- ✓ Cut 2 pieces of felt.
- ✓ Pin the pieces together.
- ✓ Thread needle, use double thread.
- ✓ Stitch together with overhand stitch.
- ✓ Leave 2 inches open. Stuff.
- ✓ Stitch opening closed.

Loop — to — Loop

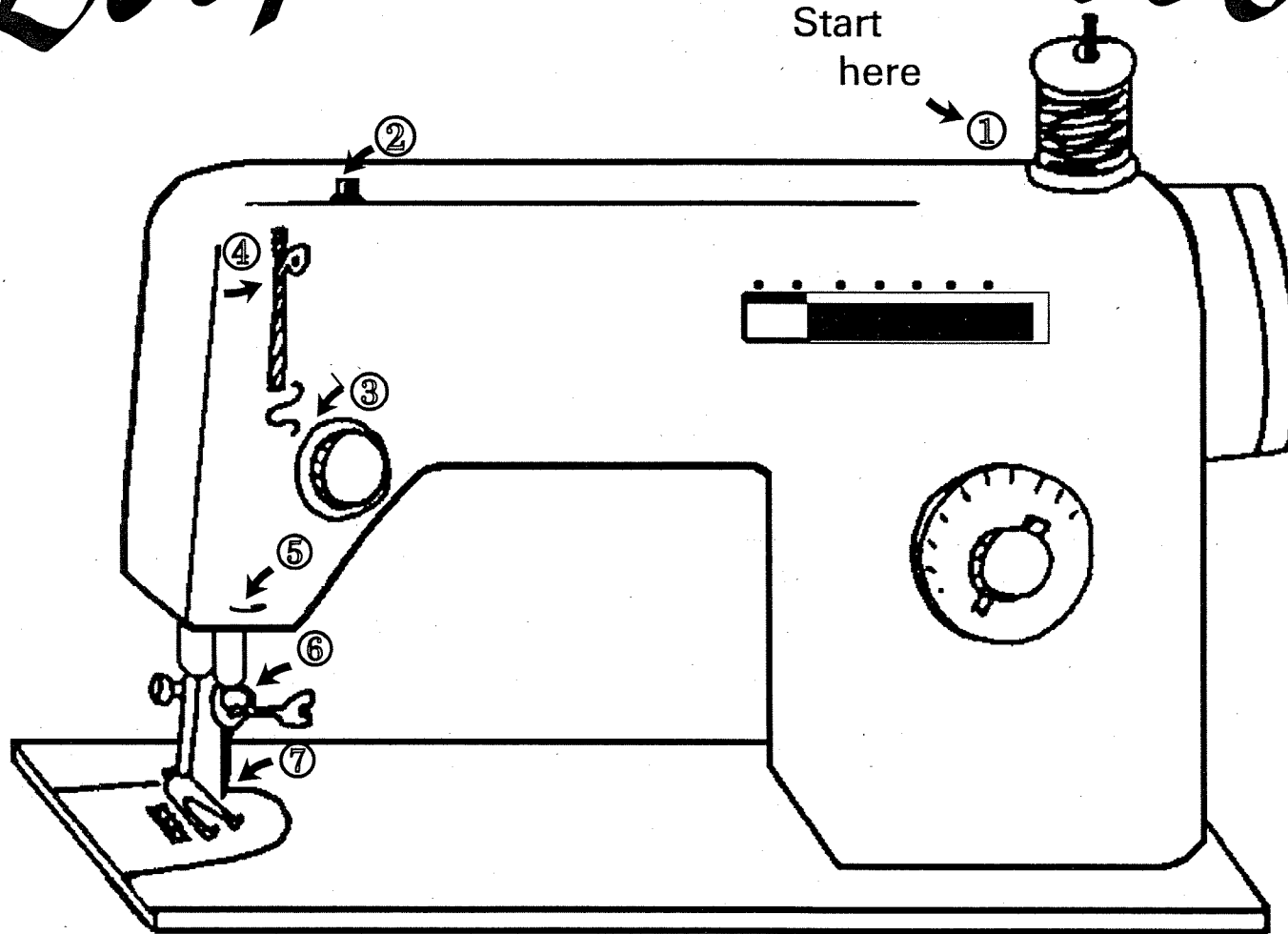

Follow the numbers to thread the machine correctly. These LOOPS are

called

9 5 7 3 1 2 4 10 6 2 3 8

codes: A(1) D(2) E(3) G(4) H(5) I(6) R(7) S(8) T(9) U(10)

Recycling

Sewing

Sharing

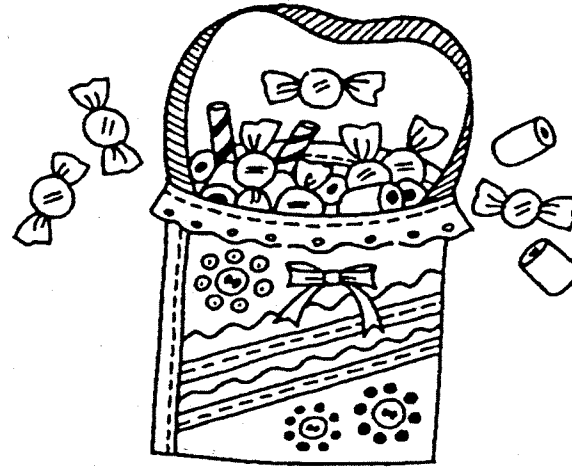

You will need:



- | | |
|--|---|
| <input type="checkbox"/> Old jeans | <input type="checkbox"/> ribbon |
| <input type="checkbox"/> sewing machine | <input type="checkbox"/> decorations |
| <input type="checkbox"/> needle & thread | <input type="checkbox"/> buttons,
lace, paint,
fabric, etc. |
| <input type="checkbox"/> scissors | <input type="checkbox"/> popcorn |

What you do:

- cut off jean's leg
- stitch bottom closed
- stitch ribbon onto each side at top for handle
- decorate
- fill with popcorn, candy (or whatever you like) to give as a gift!

Share your skills with others.



Fill your bag with candy



and give to someone you care about.



Stuff and Hug !

You will need:

- sewing machine
- old t-shirt
- needle and thread
- fabric scraps, lace, ribbon, buttons, paints, etc. (optional)
- stuffing



Do it again!



Step 1: sew the bottom and sleeves closed.

Step 2: decorate your t-shirt (optional).

Step 3: stuff the t-shirt through the neck.

Step 4: stitch the neck closed.

Colorful Clothes... Be a Color Chemist!

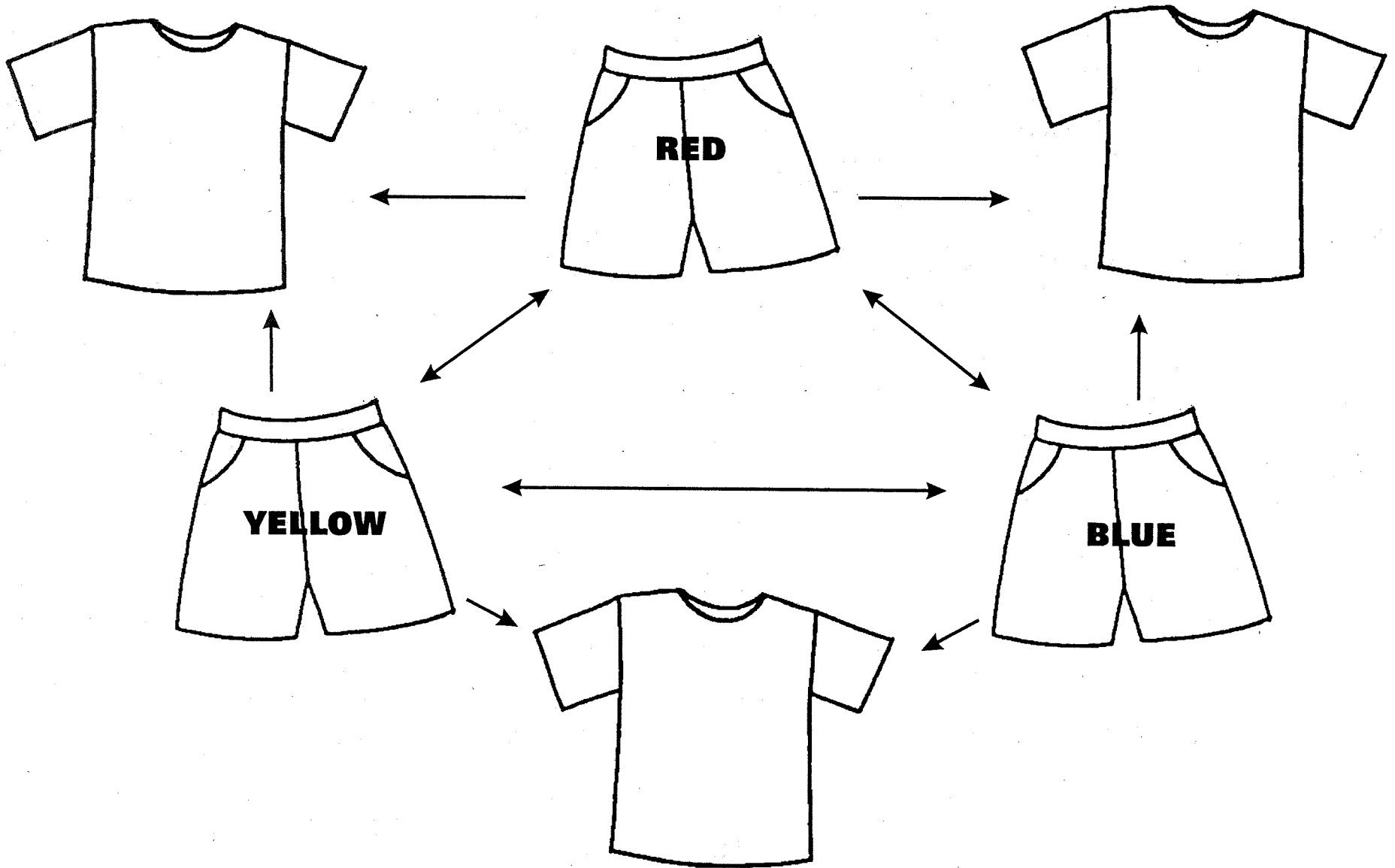

What colors are your shirts? _____

Posture Check-up!

Try This!

- Stand with your back to a wall.
- Place heels 4 inches from the wall.



What parts of your body touch the wall? _____

(back of head, shoulders and buttocks)

- Pull your waist back until only 1 or 2 hands can be placed between your body and wall at your waist.
- Now, keep every part in place and walk forward!

Make

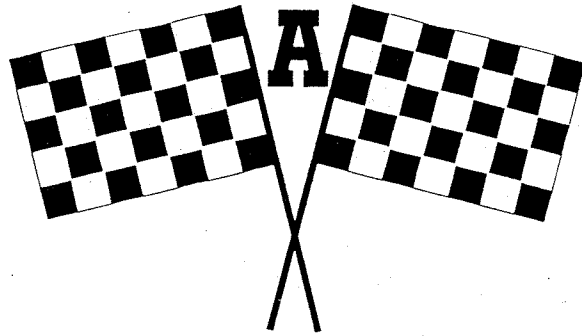

Checker Board

Weaving is one way that fabric is made. Try weaving to make this checkerboard!

You will need:

- 2 sheets of colored paper (different colors) (8½ x 11)
- 1 sheet of construction paper
- scissors
- tape

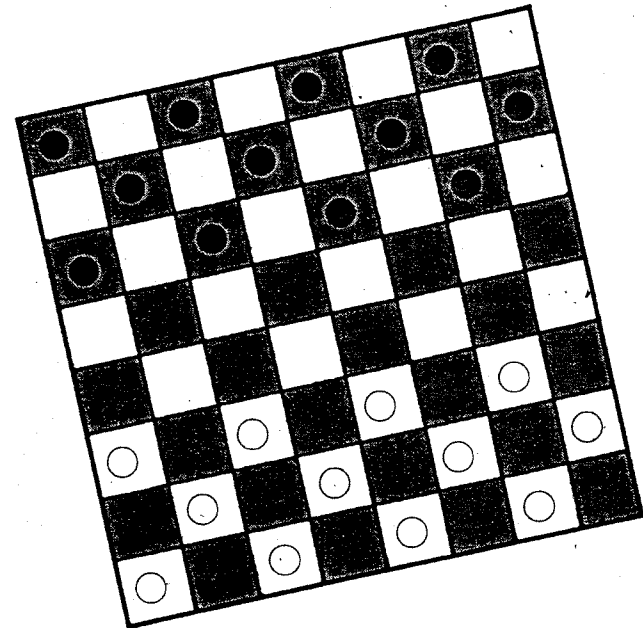

What you do:

- ✓ Measure and cut 8 1-inch strips from each of the 2 colored sheets of paper.
- ✓ Tape 8 strips of 1 color to the sheet of construction paper.
- ✓ Weave other colored strips over and under taped strips.



A Closer Look at Fabrics!

You will need:

- Magnifying glass
- Different fabrics

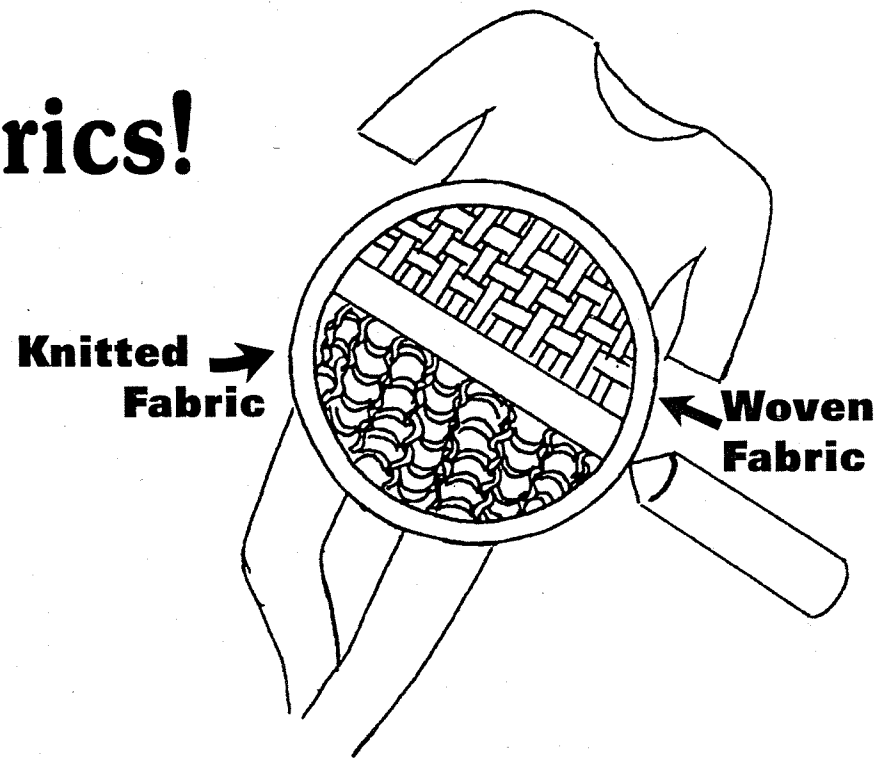

What to do:

- ✓ Look at your fabric.
- ✓ What do you see? _____

- ✓ Pull some yarns from scraps of fabric.
Look at them under your magnifying glass.
Untwist them to find the smallest part, called a fiber.



TALKING COLORS!

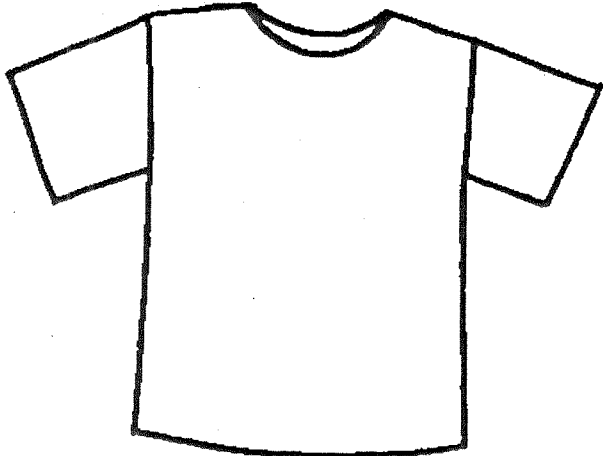

SAD COLOR

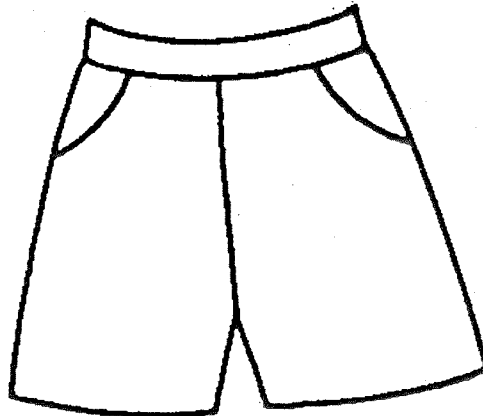

SHY COLOR

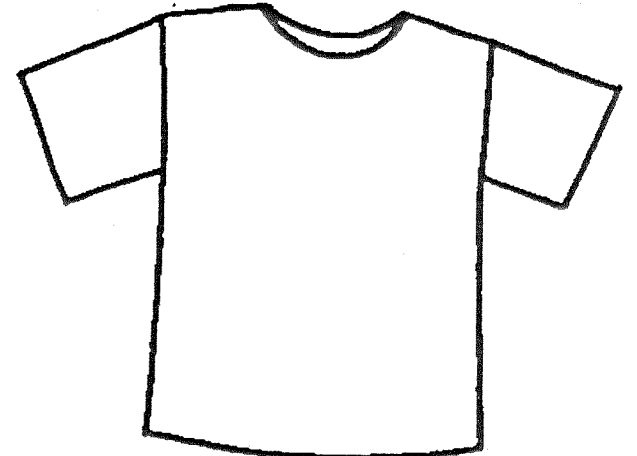

LOUD COLOR

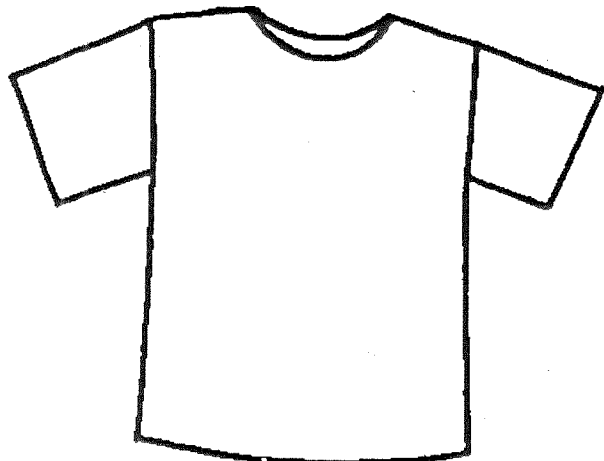

HAPPY COLOR

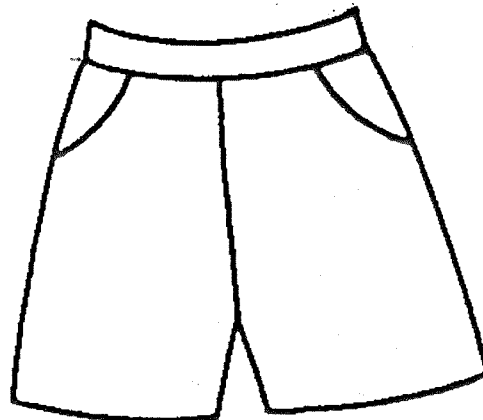

BOLD COLOR

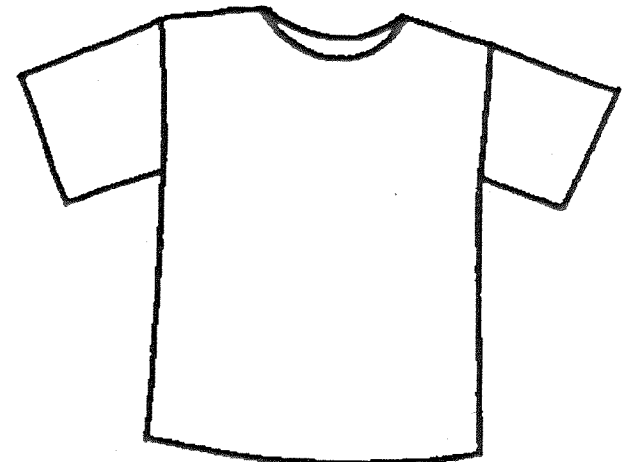

SOFT COLOR

Paste fabric samples that you think express these thoughts!

Cool
Carl!

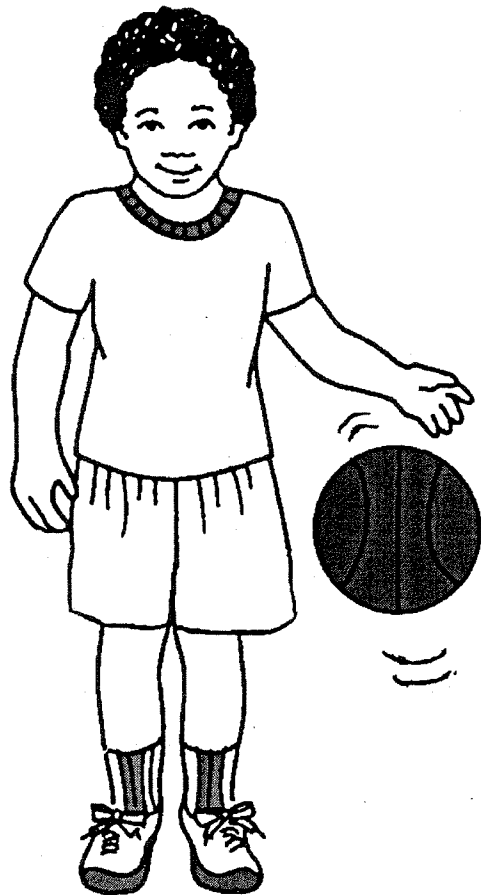

Warm
Wanda!



Cut out fabric clothes for Carl and Wanda. Choose **COOL** and **WARM** colors. Paste your choices to each.

Which one do you like?

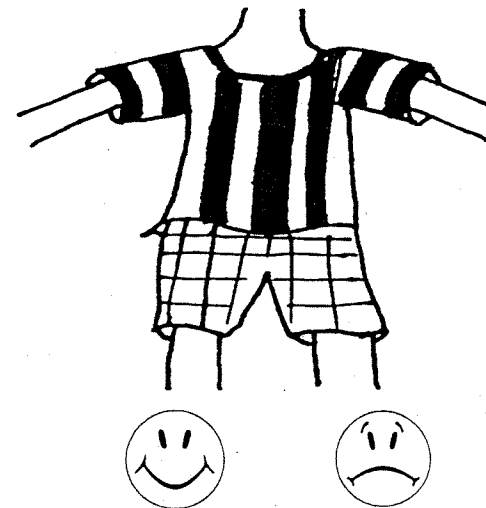
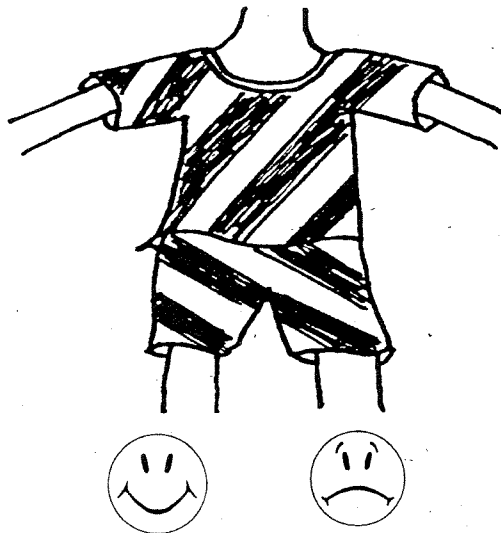
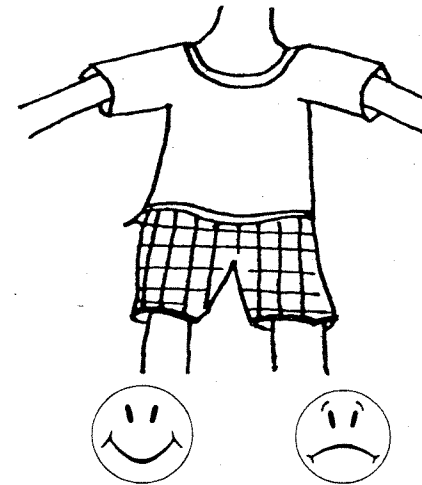
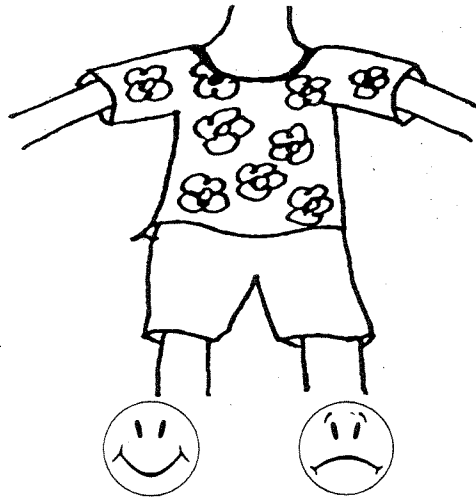
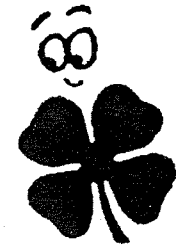

Color the happy face if you like, the sad face if you don't!

Label Lingo

Color the pictures of the three things to look for on a label and unscramble the words to match the pictures!

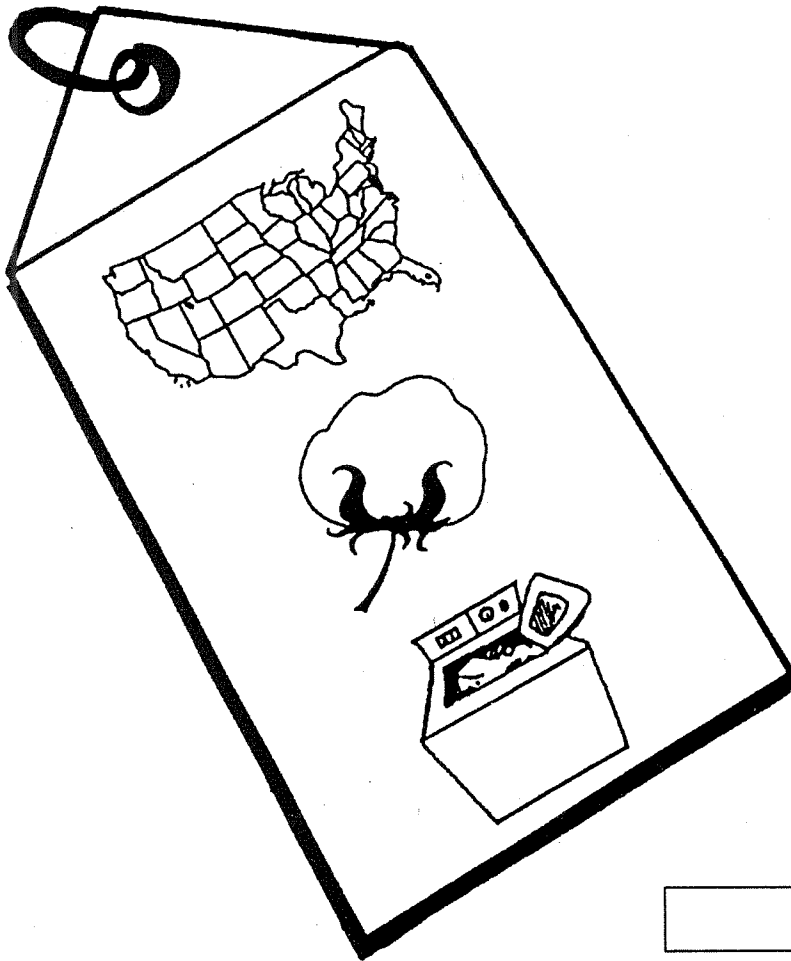

YNOTRUC

BIFRE TOENCTN

RACE

ANSWER: Country: Fiber Content: Care

What am I?

Connect the dots for clues to this mystery! Use the codes to fill in the blanks.

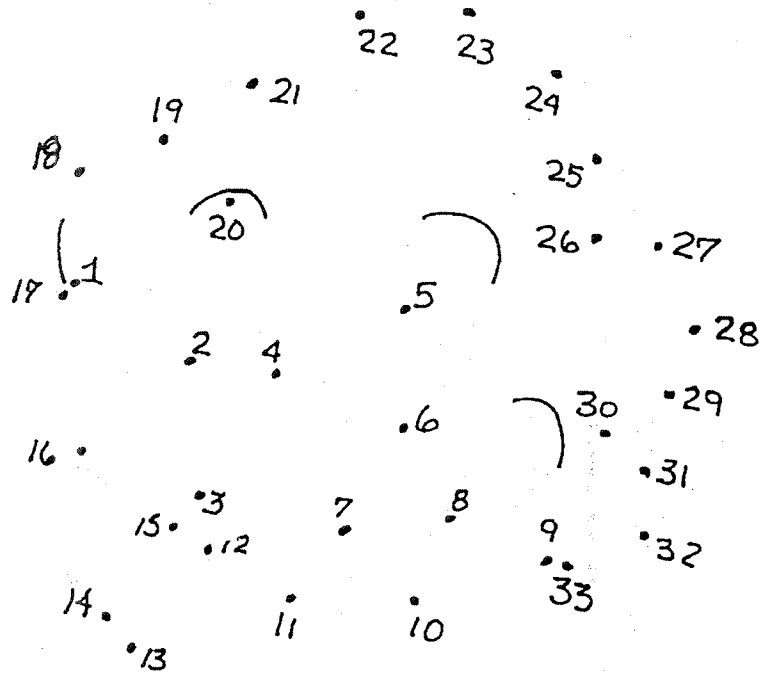

I am a

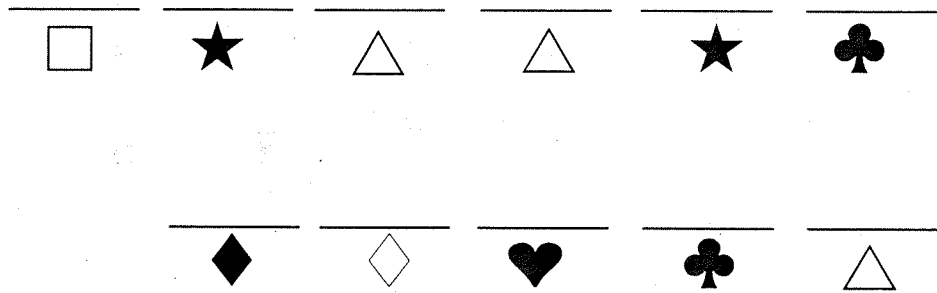

I am used to make



Clothing a r e

Find and circle the "Clothing Care" words
that are across and down.

Word Search!

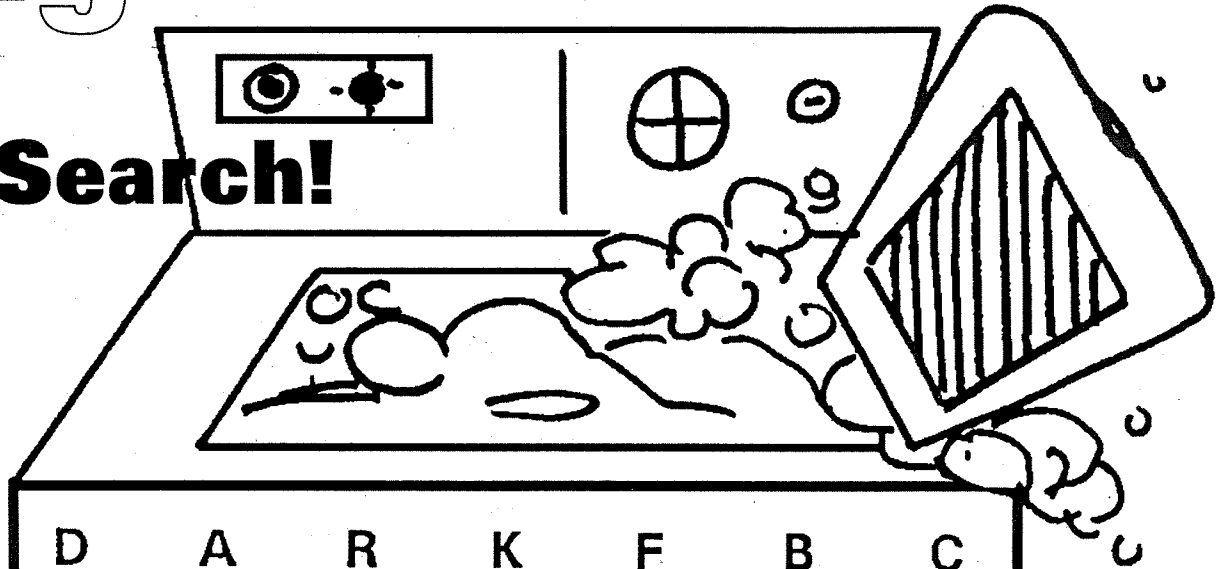

LAUNDRY

SORT

STAIN

COLORS

DARK

LIGHT

FOLD

WASH

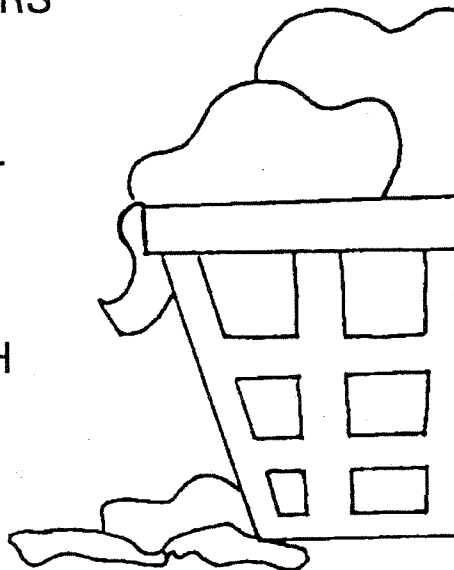

D	A	R	K	F	B	C
C	T	S	B	L	A	O
O	N	E	S	O	R	T
L	A	U	N	D	R	Y
O	G	X	H	A	F	L
R	E	W	A	R	O	I
S	T	A	I	N	L	G
C	O	S	D	A	D	H
F	A	H	Y	N	K	T

How did you do?



List the items you made:

What did you learn?

Check the new words you learned doing this project.

___ stitch ___ knitted fabrics ___ labels

___ laundry ___ woven fabrics ___ buttons

___ fibers ___ thread ___ seam

FUN WITH CLOTHES

Your clothing and you...

Check (✓) the things you know and do...
YES SOMETIMES NO

Do you pick up your clothes and put them in the proper places?

— — —

Do you close zippers and fasten buttons before putting dirty clothes in laundry?

— — —

Do you know how to sew on a button?

— — —

Do you know how to match your clothes-- stripes, plaids, prints and colors?

— — —

Do you know how to choose clothes for special occasions?

— — —

Great Job!



Your Name

Your Address

Parent or Guardian's Name

Leader's Name

4-H Club Motto

"To make the best better"

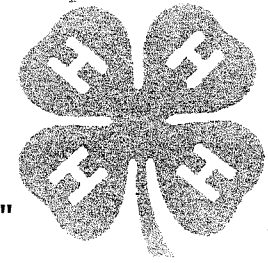

4-H Club Pledge

I pledge

my head to clearer thinking,
my heart to greater loyalty,
my hands to larger service, and
my health to better living, for
my club, my community,
my country, and my world.

4-H Club Colors Green and White



UNIVERSITY OF
FLORIDA

Authors: Shona Armstrong and Johannah Pourciau, Project Assistants, M. Joy Cantrell, Associate Professor and 4-H Youth Development Curriculum Specialist, Department of 4-H and Other Youth Programs, and R. Nadine Hackler, Professor, Clothing and Textiles, Department of Home Economics, University of Florida Institute of Food and Agricultural Sciences.

Design Team: Shirley Clark, Gadsden County; Mary Williams, Nassau County; Dot Allenbrandt, Citrus County; Judy Butterfield, Clay County; Susan Nigg, Volunteer, Manatee County; Mary Beth Salisbury, Osceola County; and Becky Conley, Volunteer, Osceola County.

Pilot Sites and Coordinators: Shirley Bond, Hillsborough County; Shirley Clark, Gadsden County; Audrey Norman, Palm Beach County; Judy Butterfield, Clay County; Shelda Wilkins, Seminole County; Mary Beth Salisbury, Osceola County; and Donna Peacock, Sumter County.

COOPERATIVE EXTENSION SERVICE, UNIVERSITY OF FLORIDA, INSTITUTE OF FOOD AND AGRICULTURAL SCIENCES, John T. Woeste, Director, in cooperation with the United States Department of Agriculture, publishes this information to further the purpose of the May 8 and June 30, 1914 Acts of Congress; and is authorized to provide research, educational information and other services only to individuals and institutions that function without regard to race, color, sex, handicap or national origin. Single copies of extension publications (excluding 4-H and youth publications) are available free to Florida residents from county extension offices. Information on bulk rates or copies for out-of-state purchasers is available from C.M. Hinton, Publications Distribution Center, IFAS Building 664, University of Florida, Gainesville, Florida 32611. Before publicizing this publication, editors should contact this address to determine availability. Printed 3/94.

1. This document is 4HCCM10 of the Florida 4-H Youth Development Program, Florida Cooperative Extension Service, Institute of Food and Agricultural Sciences, University of Florida. Published in 1994; Reviewed June 2002. Please visit the EDIS website at <http://edis.ifas.ufl.edu>.
2. Shona Armstrong and Johannah Pourciau, Project Assistants, M. Joy Cantrell-Jordan, Associate Professor and 4-H Youth Development Curriculum Specialist, Department of 4-H and Other Youth Programs, and R. Nadine Hackler, Professor, Clothing and Textiles, Department of Home Economics, University of Florida Institute of Food and Agricultural Sciences.



COOPERATIVE EXTENSION SERVICE, UNIVERSITY OF FLORIDA, INSTITUTE OF FOOD AND AGRICULTURAL SCIENCES, Christine Taylor Waddill, Director, in cooperation with the United States Department of Agriculture, publishes this information to further the purpose of the May 8 and June 30, 1914 Acts of Congress; and is authorized to provide research, educational information and other services only to individuals and institutions that function without regard to race, color, age, sex, handicap or national origin. The information in this publication is available in alternate formats. Single copies of extension publications (excluding 4-H and youth publications) are available free to Florida residents from county extension offices. Information on copies for out-of-state purchase is available from Publications Distribution Center, University of Florida, PO Box 110011, Gainesville, FL 32611-0011.